



ORIENT
TECHNOLOGIES

IT ENABLE SERVICES



Common Objectives:

- ▶ Service operation: The way in which the service is delivered
- ▶ User experience: The user's direct experience of the service
- ▶ Service outcome: The benefits and results of the service for the customer
- ▶ Value: The benefits the user perceives as inherent in the service, weighed against the cost of the service.

Managed IT Services

Multivendor Support

**Facility
Management Service**

Professional Service

Professional Service

ONE SERVICE CONCEPT

30⁺ Years of
Service
Excellence



INFRASTRUCTURE
MANAGEMENT
SERVICE

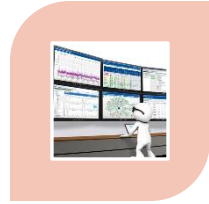

NOC MONITORING



MANAGED HELP
DESK SERVICES

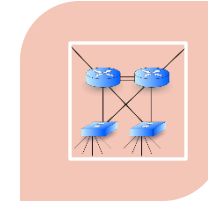

MANAGED
NETWORK SERVICES



MANAGED
SECURITY SERVICES

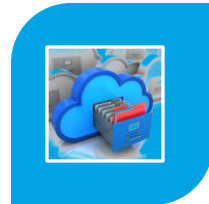

BACKUP AS A
SERVICES



MANAGED
SOFTWARE AS A
SERVICE



MANAGED CLOUD
SERVICES

- Monthly , Quarterly , Monthly , Quarterly , Yearly Billing options
- Tiered packages charge based on the number of included service features
- Additional advanced feature is priced separately based on the requirement
- Yearly Billing options feature is priced separately based on the requirement

INFRASTRUCTION MONITORING & MANAGEMENT SERVICES

30⁺ Years of Service Excellence



- ▶ Monitoring performance of servers 24/7
- ▶ Hybrid Cloud Monitoring
- ▶ Troubleshooting and resolution of bottlenecks
- ▶ Monitoring key business services
- ▶ Securing servers against internal and external threats
- ▶ Analyzing server usage trends for optimal capacity planning
- ▶ System Administration
- ▶ Data center device management
- ▶ Performance & Availability Management
- ▶ Vendor Management

Benefits:

- Pure View of your IT Infrastructure
- Key business services availability
- Better uptime, SLA and User Satisfaction
- Process standardization
- Operational efficiency

MANAGED CLOUD SERVICES

30⁺ Years of
Service
Excellence



- Provisioning
- Cost Optimization
- Security and compliance Security and compliance management
- System monitoring, alerting and reporting
- Architecture guidance
- System administration and Operations
- Database administration
- Performance testing and tuning
- Backup and disaster recovery
- lifecycle management

Benefits:

- Predictable cost spending
- Cut down infrastructure costs
- Proactive Support
- Security and Compliance

BACKUP AS A SERVICE

30⁺ Years of
Service
Excellence



Veeam-powered BaaS and DRaaS



Infrastructure
Protection



Offsite Backup &
Disaster Recovery



Public Cloud
Protection

Universal Services: Migration, Automation and APIs

- Monthly subscription model
- Reduce Upfront Capital Costs
- 99.99% Uptime Reliability
- End-to-End Security/Encryption
- Reduce Time & Costs Associated with Backups
- Flexible, Define Your Own Backup Frequency (RPO)
- Easily Restore Desired Data
- Less Strain on Your Network
- Maximize IT Operational Efficiency

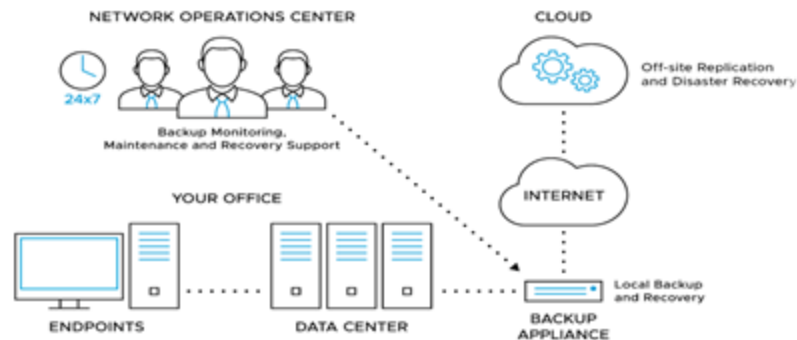

CUSTOMER REFERENCE – MS

30⁺ Years of
Service
Excellence



Client Name	Industry Segment	Service Yrs.	Service Type (Remote)	Location
MSEDCL	Govt	3	Cloud Managed Service	AWS
Paymate	Payment solution provider	1	Cloud Managed Service	AWS
Kochi Metro	Govt	2	Cloud Managed Service	AWS
RMC	Concrete Manufacturers	2	Cloud Managed Service	AWS
Avalon Healthcare Solutions	Healthcare	1	Infra Monitoring Service	US
Hazel Mercantile Limited	Trade & Distribution	10+	Infra Management Service	Singapore , UAE, Mumbai
Nayara Energy Limited	Oil & Gas	3	Infra Monitoring Service	Mumbai , Vadinar
Lodha	Real estate company	3	Infra Management Service	Mumbai
Roha Dyechem	Food colors industry	5+	Infra Management Service	Mumbai
Supreme Industries	Plastics industry	1	Network Monitoring Service	60+ locations in India
Henkel Adhesives	adhesives and sealant	1	Infra Monitoring Service	Pune
Avantgarde Solutions	Consulting and back-office services	5+	Infra Management Service	Pune

MULTIVENDOR SUPPORT SERVICES

30⁺ Years of
Service
Excellence



Bronze

- Break-Fix & Maintenance
- SLA Based AMC

Silver

- Break-Fix & Maintenance
- HW/SW Asset Management**
- SLA Based AMC

Gold

- Break-Fix & Maintenance
- HW/SW Asset Management**
- SLA Based AMC
- Proactive Monitoring Service**

- SLA Based Annual Maintenance Contract
- Proactive support packages
- Clear View of IT Assets and lifecycle.
- Predictive failure identification.

CUSTOMER REFERENCE – MVS

30⁺ Years of
Service
Excellence



Client Name	Industry Segment	Service Years.	Asset Count	Supported Devices	Location
Kokilaben Dhirubhai Ambani Hospital	Healthcare Centre	1	1027	Server support, EUD	MH , Gujarat
DBS	Banking and Financial services	3	2000	EUD	PAN INDIA
Dr Batras Positive Health Clinic Pvt Ltd	Healthcare Industry	5	851	Server support, EUD	PAN INDIA
INOX Leisure Ltd	Multiplex chain	2	509	Server support	PAN INDIA
Vasai Vikas Sahakari Bank Limited	Banking and Financial services	5	461	Server support, EUD	Mumbai
Henkel Adhésives Technologies India Pvt Ltd	adhesives and sealant	3	436	Server support, EUD	MH, Delhi, Chennai, Bengaluru
Unichem Laboratories Ltd	Pharmaceuticals	5	316	Server support, EUD	MH
Oberoi Realty Limited	Real Estate	5	253	EUD	MH, Delhi
Equifax Analytics Pvt Ltd	Analytics firm	2	246	Server support, EUD	MH, Bengaluru
Equifax Credit Information Services Pvt Ltd	Credit reporting agencies	2	182	Server support, EUD	MH, Bengaluru

FACILITY MANAGEMENT SERVICES

30⁺ Years of
Service
Excellence



Onsite

- End User Management
- DC Infra Management
- Staff Augmentation
- Contact Center Management
- Cluster Support Service

Offsite

- Dedicated Remote Infra Management
- SME Engagements
- Capacity Advisory
- Oncall Support Service

Hybrid

- Onsite + Offsite Support Model

- Solutoned with Intelligent systems, Ind. Standard process, Skilled Professionals
- Controlled transition & Strong Governance method.

CUSTOMER REFERENCE – FMS

30⁺ Years of
Service
Excellence



Client Name	Segment	RE Count	Service Yrs.	Service Skills	Location
Hewlett Packard	IT	100	5 Yrs	Service Desk	MH
Nayara Energy (Essar Oil)	Oil & Gas	90	3 Yrs	IT, NOC, Contact Centre	PAN INDIA
National Payments Corporation Of India	BFSI	56	5 Yrs	DC Infra Mgmt.	PAN INDIA
Cromptan and Greaves	Manufacturing	25	3 Yrs	EUS	PAN INDIA
Mastek	Software	22	4 Yrs	EUS, DC Infra Mgmt.	MH
Mazgaon Ship builders	Manufacturing	20	3 Yrs	EUS, DC Infra Mgmt.	MH
Castrol India Pvt Ltd.	Oil & Gas	14	4 Yrs	EUS, DC Infra Mgmt.	PAN INDIA
Emirates Airlines	Airlines	13	3 Yrs	EUS, DC Infra Mgmt.	PAN INDIA
Unichem Laboratories Ltd	Pharmaceuticals	10	4 Yrs	EUS, DC Infra Mgmt.	MH
In-Solutions Global (ISG)	Financial Services	5	1 Yr	DC Infra Mgmt.	MH
Bank of baroda	Banking Services	15	1 Yr	Cirtix support , EUC	MH , Gujarat
HDFC Security	Banking Services	5	1 Yr	Cirtix support , Loadbalancer	MH
Sodexo	Financial Services	15	1 Yr	server support , EUC	MH

PROFESSIONAL IT SERVICES

30⁺ Years of
Service
Excellence



IT Consultancy
& Advisory
Service

Project
Management
Service

Implementation
Migration
Service



Infrastructure assessment

Assess customer infrastructure
Analyse and identify gaps
plan and remediate
observed gaps(optional)

Implementation service

HCI implementation
App/Desktop Virtualization
Server/Storage Virtualization
Network Virtualization
Cloud infra setup
SD-WAN deployment
Messaging solutions
Network Security Solutions
Etc...

Migration service

on-prem to cloud
Physical to Virtual
Virtual to Virtual
Mail migration
Storage Migration
OS Upgradation
etc....

Remote Project Management Service

CUSTOMER REFERENCE – PS



- QUATRRO BUSINESS SUPPORT SOLUTIONS PRIVATE LIMITED
- Protiviti Inc.
- ORIENT IT SERVICES
- Inter Prompt Global
- Quattris Global Ltd.
- Huawei Technologies Co. Ltd.

Providing professional services on various technologies and products like O365 implementation & migration, Citrix VAD Implementation & Consulting, HCI Implementation, Cloud migration, Infra Migration Services , Infra assessment , network integration, Project management Etc.

ITSM & NMS TOOLS

30⁺ Years of
Service
Excellence



ITSM

NMS

IT Service Management	Network Management and Monitoring	Log Management & Flow Analytics
Incident Management	Network Monitoring	Network Log Monitoring
Problem Management	Server Monitoring	Server Log Monitoring
Change Management	Cloud Monitoring	NetFlow Monitoring
Release Management	Virtualization Monitoring	Custom Log Monitoring
Asset Management	URL Monitoring	App Log Monitoring
Knowledge Management	Application Monitoring	Flow Monitoring
Patch Management	Database Monitoring	

- We are partnered with Kaseya , Motadata and FreshService
- Flexible options available as customer managed and Partner managed solutions



PROZM® ITAM Framework

- **Introduction**

- ITAM framework is conceptualized and evolved with the basic aim to assist ITAM professionals in planning and Implementing IT Asset Management System.

- **Systematic IT Asset Management**

- Organizational Management
- Planning and Implementation
- Operations Management
- Performance Evaluation and Improvement

- **Guidelines how mapping is done**

- Mapping from ISO/IEC 19770-1:2017 to PROZM® ITAM Framework



- Virtual CISO services help you in Providing ISMS leadership for your organization
- Help in crafting a practical risk management program for Information assets
- Identify right mix of people, processes and technology solutions to ensure information security
- Providing timely, crisp and board friendly updates on Cyber programs
- Nurture partnership with eco system for sustainable operations
- We can customize service duration, hours of operations and mode of engagement to best suit your organization needs

Security Advisor

Security
leadership

Interim CISO

Training
and Awareness

Gap
Assessment

ISMS
implementation

Strategy and
Roadmap

Risk
Management



- All forward-looking enterprises leverage technology for business decisions. IT is a Technology intensive function and needs leadership.
- Leadership helps in bridging the Business-IT divide and provide a strategic approach to IT
- There is a difference between a CIO and an IT Head. Many a times, we confuse between the two roles and end up with expectations mismatch

- **CIOs provide strategic direction to IT, which includes:**
 - Roadmap for Application and Infrastructure
 - Scalability aligned to business goals
 - Team organization and management
 - Skills upgradation and business alignment
 - Driving business sponsored technology projects
 - Nurture a culture of innovation and develop partner eco system
 - Budgeting and eliminating deadwood

METHOD OF ENGAGEMENT

30⁺ Years of
Service
Excellence



How we do it ?

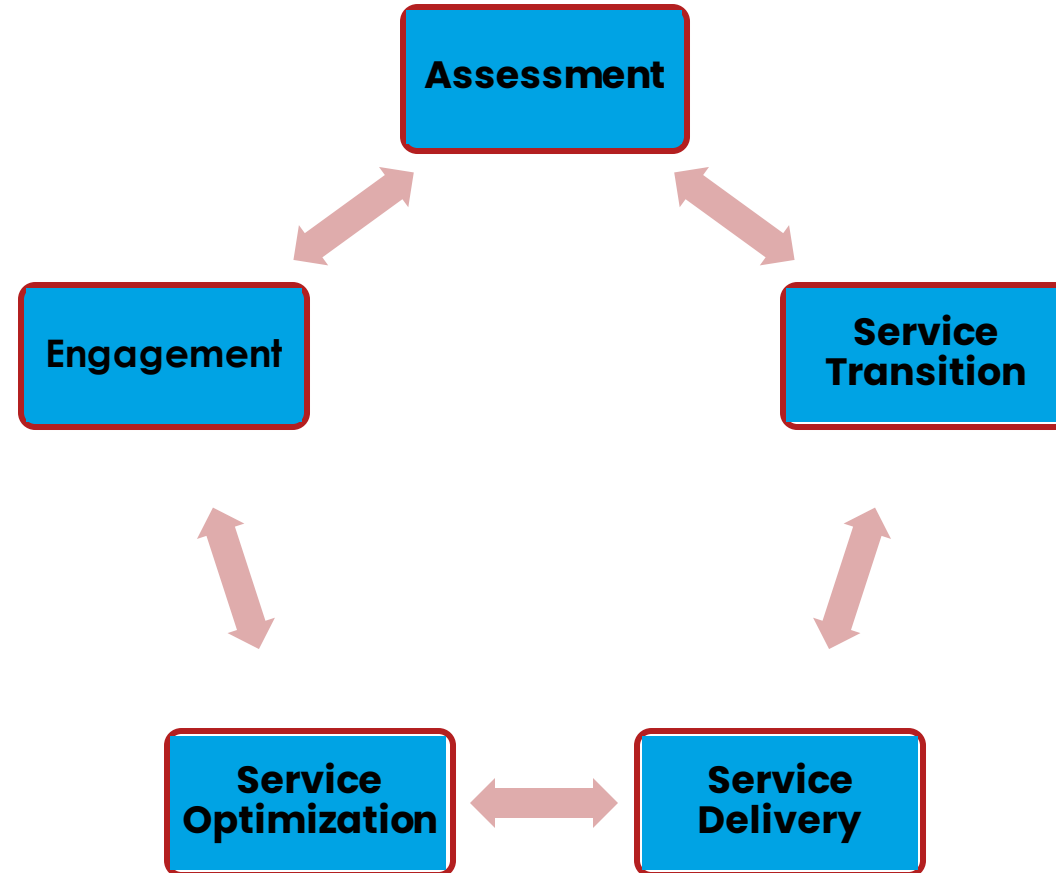

ONE SERVICE TEAM

30⁺ Years of
Service
Excellence



Contract Management Team

Responsible to maintain and manage all Contracts , SLA , Commercials with Customers, Vendors and Partners.



Vendor Management Team

Is responsible to prepare and maintain healthy engagements with vendors to support delivery model as and when required.



Project Management Team

Responsible to Deliver all Project as per the SOW defined and assured customer satisfaction



Technical Support Team

Responsible to work with customer to address and resolve customer support requests according to the SLA.



Quality Control

Performance Monitoring and measurement, capture and maintain Customer delight, Manage operational efficiency etc.



DEPARTMENT HIERARCHY

30⁺ Years of Service Excellence

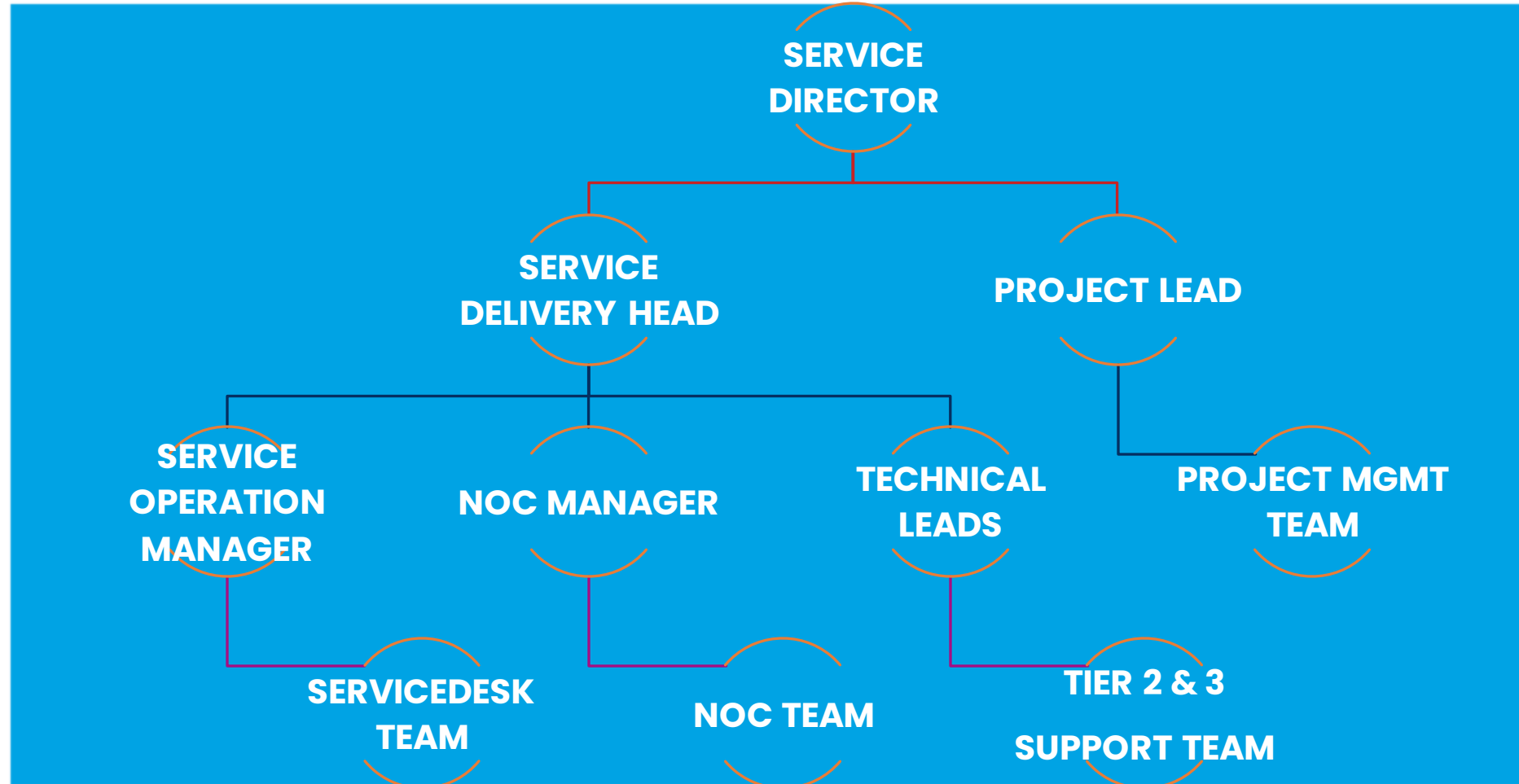

SUPPORT MODEL

30⁺ Years of Service Excellence

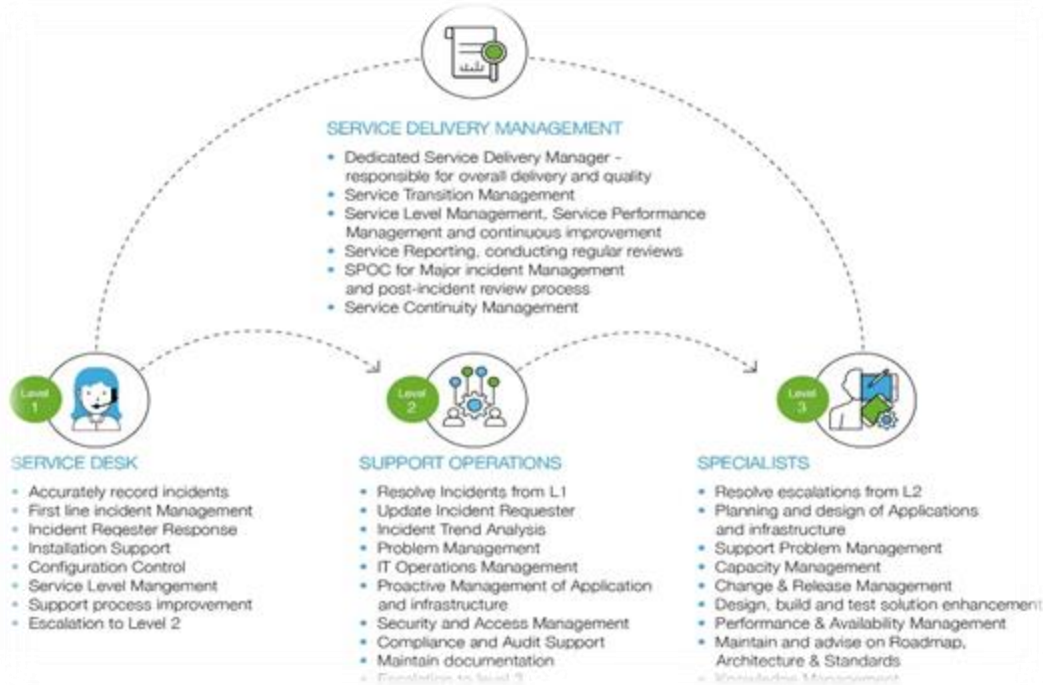

- Centralized service delivery
- 24*7 NOC Monitoring & Operations
- Remote support desk
- On field services
- Single console operation for technicians
- Mobile app for field technicians
- workflow enabled process
- Pool of Subject Matter Experts
- Multichannel Ticketing
- Workflow enabled ticketing process

- Dedicated Service delivery management team
- SLA & incident reporting
- Contract Management & Tracking
- Service portal access to clients for raising and tracking support request.
- Project tracking
- T&M Tracking

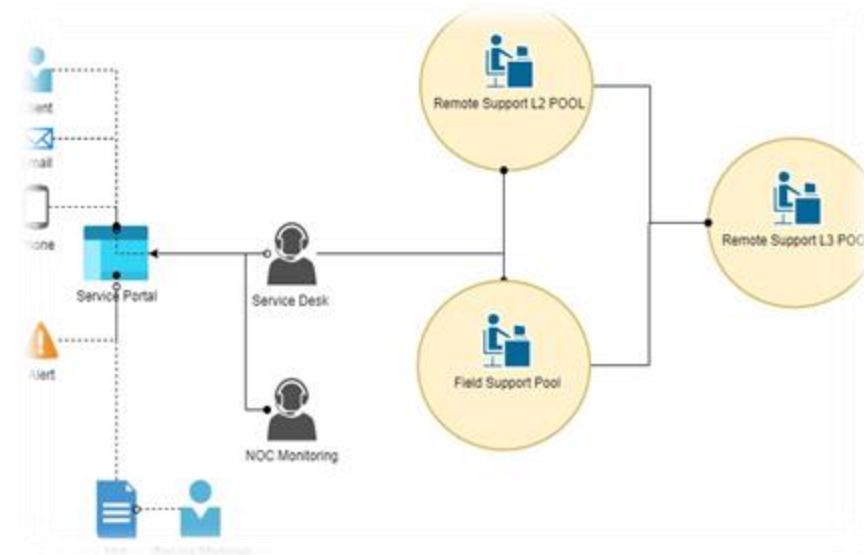

NOC ARCHITECTURE

30⁺ Years of Service Excellence

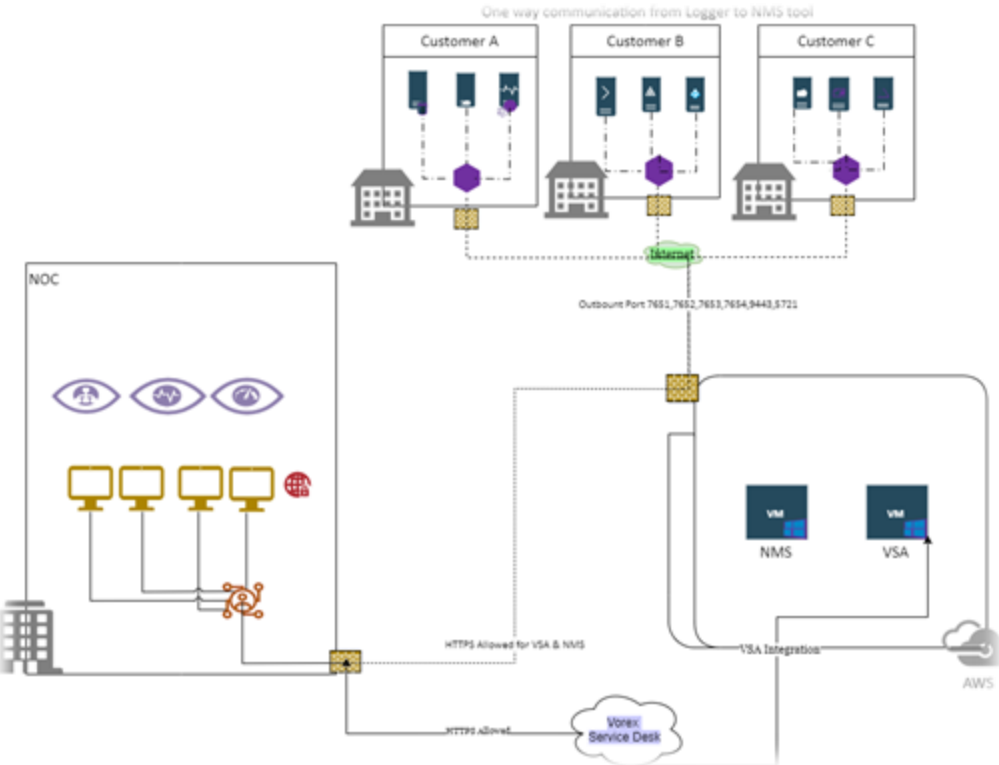

- NOC Network is physically isolated from Orient offices and Customer offices.
- Daily Log Collection for all security devices are enabled to store on cloud.
- IPS, Antivirus, Web Filter, SSL Inspection is enabled on all firewall policies.
- Firewall rules are configured with Specific source and destination with specified service ports to control traffic.
- Downloads and access to media sharing sites are restricted.
- Only Business email, NMS and Service desk URLs are accessible from NOC systems
- Remote support is provided over clientless VPN & WebEx to customers.
- NOC entry is restricted to Biometric authorized personal only
- Kaseya NMS , ITSM & PSA is tightly integrated to deliver monitoring , management and professional service automation.

TOOLS USED TO SUPPORT



ENTERPRISE DC MONITORING



IT SERVICE MANAGEMENT



PROFESSIONAL SERVICE AUTOMATION

ONBOARDING

30⁺ Years of
Service
Excellence

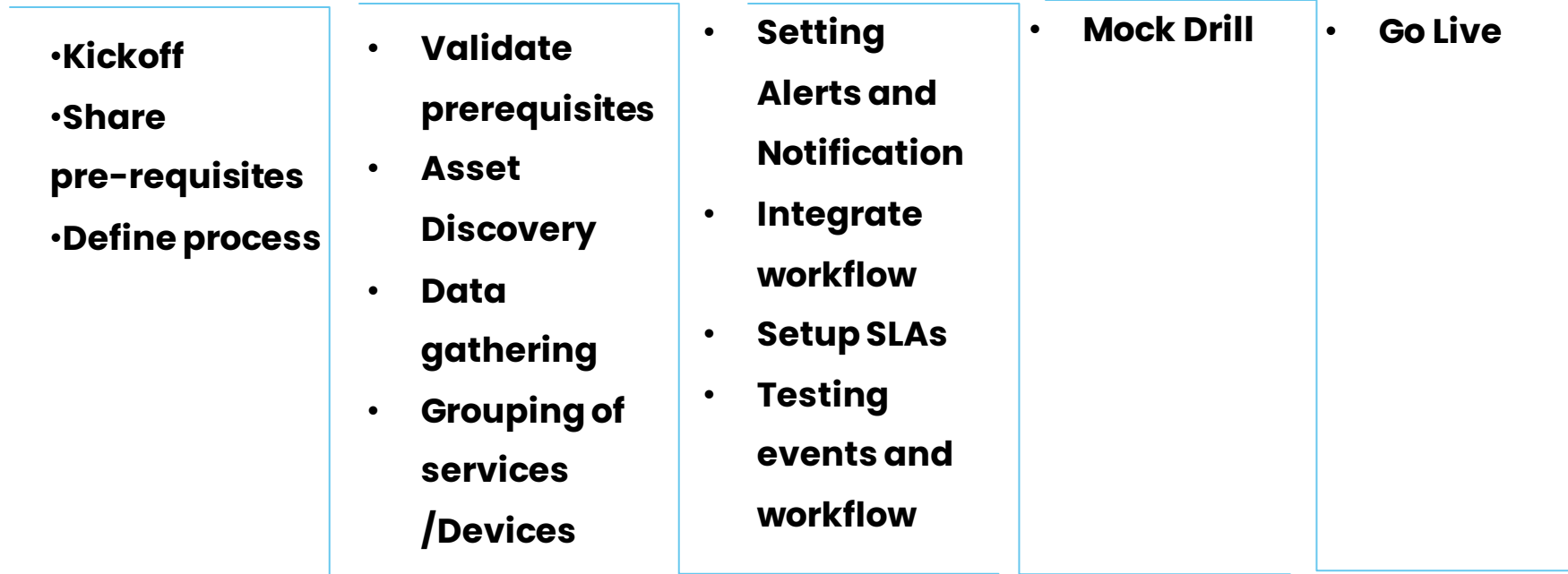



30⁺ Years of
Service
Excellence



CONTACT Us

Sales Office

502, 5th Floor, Ackruti Star,
Central Road, M.I.D.C.,
Andheri (E), Mumbai – 400 093.

Service Office

2-3, Neeraj Industrial Estate,
Off. Mahakali Caves Road, Behind Paper
Box, Andheri East, Mumbai – 400 093.

Board Line : **+91-22-4292 8888**

Fax Line : **+91-22-4292 8800**

Mail id : **inquiry@orientinda.net**

www.orientindia.com